

4287

Moderate Rate CC Cell Lithium Thionyl Chloride

150MR Series

Physical Characteristics

Cell Drawing

Chemistry	Thionyl Chloride
Construction	Dual Anode
Cell Size	CC
Length¹	102.9 mm
Diameter²	24.9 mm
Cell Weight	96.0 g
Lithium Weight	4.6 g
Integrated Safety Fuse	N/A

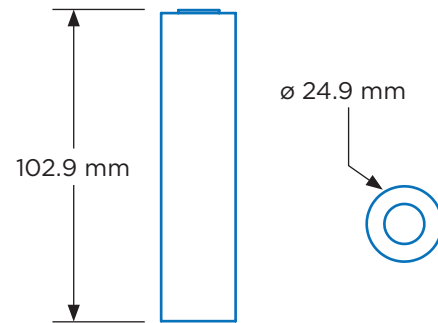

Electrical Characteristics

Discharge Curve
100 mA, 23°C

Cell Type	Primary
Open Circuit Voltage (25°C)	3.67 V
Nominal Capacity	13 Ah
Maximum Continuous Current	190 mA
Operating Temperature	-40°C to +150°C
Self Discharge Rate	<2% per year
Storage Temperature	≤25°C
Discharge Condition	100 mA, 23°C

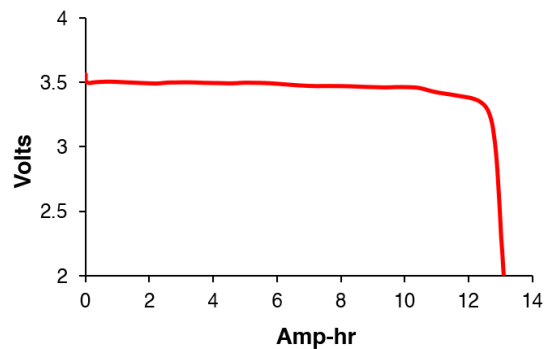

Key Features

- Primary chemistry (non-rechargeable)
- Moderate rate capability
- Stainless steel container
- Hermetic glass-to-metal sealing
- Built to withstand extreme shock and vibration
- Restricted for transportation (Class 9)
- Custom terminations available

Main Applications³

- Downhole oil & gas
- Measurement While Drilling (MWD)
- Logging While Drilling (LWD)
- Military devices

NOTE: ¹The information on this datasheet is for marketing purposes only. Please consult with Electrochem for more information regarding how our cells will perform within your application. ²The information in this document is subject to change without notice and does not constitute a warranty of performance. ³This product and its external electrical contact materials are RoHS compliant. See our "RoHS Statement" for more information. ⁴The length dimension was based off of a flat termination. The use of other terminations will impact overall cell length. ⁵Diameter measurements include shrink when applicable. ⁶The "Main Application" list does not include all potential applications, please consult Electrochem for your application needs.