

3B1065

High Rate AA Cell

Lithium Sulfuryl Chloride

PMX150 Series

Physical Characteristics

Cell Drawing

Chemistry	Sulfuryl Chloride
Construction	Spiral
Cell Size	AA
Length¹	53.1 mm
Diameter²	13.7 mm
Cell Weight	17.0 g
Lithium Weight	0.3 g
Integrated Safety Fuse	Yes

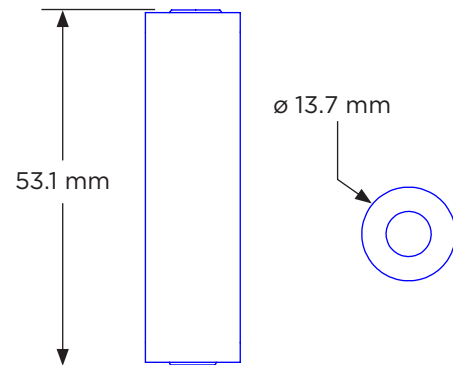

Electrical Characteristics

Discharge Curve
20 mA, 120°C

Cell Type	Primary
Open Circuit Voltage (25°C)	3.93 V
Nominal Capacity	1.7 Ah
Maximum Continuous Current	150 mA
Operating Temperature	-20°C to +150°C
Self Discharge Rate	<3% per year
Storage Temperature	≤ 25°C
Discharge Condition	20 mA, 120°C

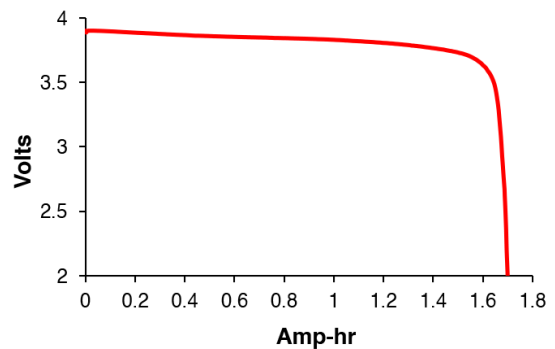

Key Features

- Primary chemistry (non-rechargeable)
- High rate capability
- Advanced spiral-wound technology
- Stainless steel container
- Hermetic glass-to-metal sealing
- Restricted for transportation (Class 9)
- Custom terminations available

Main Applications³

- Military communications
- Oceanographic buoys and gliders
- Tracking systems
- Sensor systems
- Pipeline inspection gauges
- Beacons, transponders and receivers
- Seismic surveying birds

NOTE: ¹The information on this datasheet is for marketing purposes only. Please consult with Electrochem for more information regarding how our cells will perform within your application. ²The information in this document is subject to change without notice and does not constitute a warranty of performance. ³This product and its external electrical contact materials are RoHS compliant. See our "RoHS Statement" for more information. ⁴The length dimension was based off of a flat termination. The use of other terminations will impact overall cell length. ⁵Diameter measurements include shrink when applicable. ⁶The "Main Application" list does not include all potential applications, please consult Electrochem for your application needs.